

# OPERATING INSTRUCTIONS

# JVC

## COLOR VIDEO MONITOR

# TM-A170G

# INSTRUCTIONS

**For Customer Use:**

Enter below the Serial No. which is located on the rear of the cabinet.  
Retain this information for future reference.

**Pour l'usage du client:**

Enter ci-dessous le numéro de série qui est situé sur l'arrière du coffret.  
Conserver cette information pour une référence ultérieure.

**Model No. :**

 Numéro de modèle : **TM-A170G**
**Serial No. :**

Numéro de série :

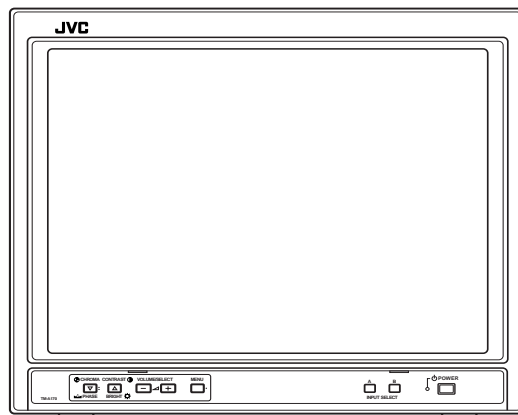

LCT1266-001A-H

# SAFETY PRECAUTIONS

In order to prevent any fatal accidents caused by misoperation or mishandling the monitor, be fully aware of all the following precautions.

## WARNINGS

To prevent fire or shock hazard, do not expose this monitor to rain or moisture. Dangerous high voltages are present inside the unit. Do not remove the back cover of the cabinet. When servicing the monitor, consult qualified service personnel. Never try to service it yourself.

**WARNING : THIS APPARATUS MUST BE EARTHED.**

Machine Noise Information Ordinance 3, GSGV, January 18, 1991: The sound pressure level at the operator position is equal or less than 70 dB(A) according to ISO 7778.

Improper operations, in particular alternation of high voltage or changing the type of tube may result in x-ray emission of considerable dose. A unit altered in such a way no longer meets the standards of certification, and must therefore no longer be operated.

This monitor is equipped with a 3-blade grounding-type plug to satisfy FCC rule. If you are unable to insert the plug into the outlet, contact your electrician.

## FCC INFORMATION (U.S.A. only)

**CAUTION:** Changes or modification not approved by JVC could void the user's authority to operate the equipment.

**NOTE:** This equipment has been tested and found to comply with the limits for a Class B digital device, pursuant to Part 15 of the FCC Rules. These limits are designed to provide reasonable protection against harmful interference in a residential installation. This equipment generates, uses and can radiate radio frequency energy and, if not installed and used in accordance with the instructions, may cause harmful interference to radio communications. However, there is no guarantee that interference will not occur in a particular installation. If this equipment does cause harmful interference to radio or television reception, which can be determined by turning the equipment off and on, the user is encouraged to try to correct the interference by one or more of the following measures:

- Reorient or relocate the receiving antenna.
- Increase the separation between the equipment and receiver.
- Connect the equipment into an outlet on a circuit different from that to which the receiver is connected.
- Consult the dealer or an experienced radio/TV technician for help.

## Notice (U.S.A. only)

This product utilizes both a Cathode Ray Tube (CRT) and other components that contain lead. Disposal of these materials may be regulated in your community due to environmental considerations. For disposal or recycling information please contact your local authorities, or the Electronics Industries Alliance: <<http://www.eia.org>>

## PRECAUTIONS

- Use only the power source specified on the unit. (120 V AC/230 V AC, 50 Hz/60Hz)
- When not using this unit for a long period of time, or when cleaning it, be sure to disconnect the power plug from the AC outlet.
- Do not allow anything to rest on the power cord. And do not place this unit where people will tread on the cord. Do not overload wall outlets or power cords as this can result in a fire or electric shock.
- Avoid using this unit under the following conditions:
  - in extremely hot, cold or humid places,
  - in dusty places,
  - near appliances generating strong magnetic fields,
  - in places subject to direct sunlight,
  - in badly ventilated places,
  - in automobiles with doors closed.
- Do not cover the ventilation slots while in operation as this could obstruct the required ventilation flow.
- When dust accumulates on the screen surface, clean it with a soft cloth.

## POWER CONNECTION

The power supply voltage rating of this product is AC 120 V (For U.S.A. and Canada only) and AC 230 V (For European countries or United Kingdom), the power cord attached conforms to the following power supply voltage and countries. Use only the power cord designated to ensure Safety and EMC regulations of each countries.

### Power cord



Power supply voltage : AC 120 V  
Countries : U.S.A. and Canada



AC 230 V  
European countries



AC 230 V  
United Kingdom

### Warning:

- Do not use the same Power Cord for AC 120 V as for AC 230 V. Doing so may cause malfunction, electric shock or fire.

### Note for the United Kingdom power cord only

The plug on the United Kingdom power cord has a built-in fuse. When replacing the fuse, be sure to use only a correctly rated approved type, re-fit the fuse cover.

**How to replace the fuse**  
Open the fuse compartment with the blade screw driver, and replace the fuse.  
(\* An example is shown in the illustration.)

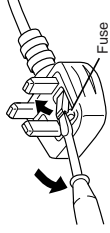

### SCREEN BURN

- It is not recommended to keep a certain still image displayed on screen for a long time as well as displaying extremely bright images on screen. This may cause a burning (sticking) phenomenon on the screen of cathode-ray tube. This problem does not occur as far as displaying normal video playback motion images.

### Supplementary Explanation

= Information for monitor operation =

- This monitor uses a high precision CRT (cathode ray tube). Please follow the procedures below.
  - \* For stable operation of the CRT, approximately 30 minutes running time is required from the time the power is turned on.
  - \* When the monitor is installed, it can be easily affected by surrounding magnetic fields, which can generate irregular color on the screen. When it is difficult to eradicate, degauss from outside using a degausser, etc.

# CONTENTS

- SAFETY PRECAUTIONS** ..... 2
- CONTROLS AND FEATURES** ..... 4
- HOW TO HANDLE BASIC OPERATIONS** ..... 7
- HOW TO USE THE MENU FUNCTIONS** ..... 8
- HOW TO INITIALIZE THE SETTING** ..... 11
- BASIC CONNECTION EXAMPLE** ..... 12
- HOW TO USE EXTERNAL CONTROL** ..... 14
- TROUBLESHOOTING** ..... 15
- SPECIFICATIONS** ..... 16

# CONTROLS AND FEATURES

## FRONT VIEW

<Front Panel>

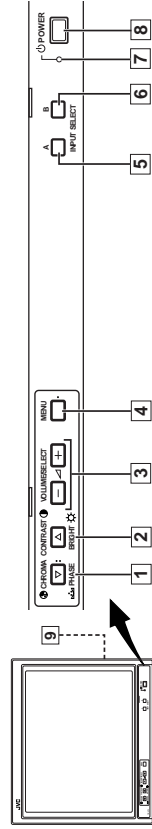

- 1 Chroma/Phase button**  
**[CHROMA/PHASE]**  
 Press this button to activate the picture color density adjustment mode or picture hue adjustment mode. Each time you press the button, the adjustment item changes.  
 Picture color density  $\pm$  Picture hue  
 Adjust the value with the VOLUME/SELECT buttons **3**. Also used as a control button in the menu function mode.
- 2 Contrast/Brightness button**  
**[CONTRAST/BRIGHT]**  
 Press this button to activate the picture contrast adjustment mode or picture brightness adjustment mode. Each time you press the button, the adjustment item changes.  
 Picture contrast  $\pm$  Picture brightness  
 Adjust the value with the VOLUME/SELECT buttons **3**. Also used as a control button in the menu function mode.
- 3 Volume/Select buttons**  
**[VOLUME/SELECT - +]**  
 Adjusts the speaker volume. Also used as a control button in the menu function mode.
- 4 Menu button [MENU]**  
 Displays and disappears the <MENU> screen. Pressing the CHROMA/PHASE button **1** with the Menu button depressed will display the <SET-UP MENU> screen.
- 5 Input A (VIDEO) button [INPUT SELECT A]**  
 Selects the video and audio signals input to the VIDEO A **11** and AUDIO A **14** terminals on the rear panel. The button lights when selected.
- 6 Input B (VIDEO Y/C) button [INPUT SELECT B]**  
 Selects the video and audio signals input to the VIDEO B **12** or VIDEO B (Y/C) **13** and AUDIO B **15** terminals on the rear panel. The button lights when selected.  
**Note:**  
 • The VIDEO B terminals include a video terminal (BNC connector) and a Y/C terminal (mini-DIN 4-pin connector). The Y/C (S-video) terminal has priority.
- 7 Power indicator**  
 Unit : The main power is OFF  
 Orange : The main power is ON, but the monitor's power is OFF (in the stand-by mode).  
 Green : The main power is ON, and the monitor's power is ON (in the normal operation mode).
- 8 Power switch [POWER]**  
 Press the power switch to turn the monitor's power ON or OFF when the main power is ON.
- 9 Speaker**  
 A built-in speaker is located inside the right side panel when the monitor is viewed from the front.

## REAR VIEW

<Rear Panel>

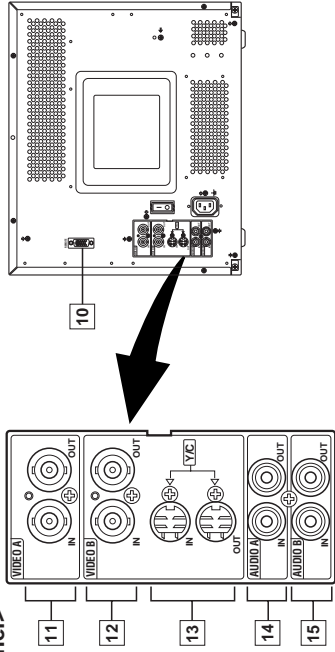

- 10 External control terminal [REMOTE]**  
 Remote terminal for external control.  
 The input signal (the INPUT function) or the aspect ratio (the ASPECT RATIO function) can be selected by external control using a switch cable. Setting of the INPUT REMOTE or ASPECT REMOTE item in the <SET-UP MENU> screen is required before using external control.  
 Refer to the HOW TO USE EXTERNAL CONTROL on page 14 for more details.
- 11 Video A terminals [VIDEO A IN/OUT]**  
 Video signal input (IN) and output (OUT) terminals.  
 The output terminal is bridge-connected.  
 IN : Video signal input terminal  
 OUT : Bridge-connected video signal output terminal  
**Notes:**  
 • For corresponding audio signals, use the AUDIO A terminals **14**.  
 • Also refer to BASIC CONNECTION EXAMPLE on page 12.
- 12 Video B terminals [VIDEO B IN/OUT]**  
 Video signal input (IN) and output (OUT) terminals.  
 The output terminal is bridge-connected.  
 IN : Video signal input terminal  
 OUT : Bridge-connected video signal output terminal  
**Notes:**  
 • For corresponding audio signals, use the AUDIO B terminals **15**.  
 • Also refer to BASIC CONNECTION EXAMPLE on page 12.
- 13 Video B (Y/C) terminals [VIDEO B Y/C IN/OUT]**  
 Y/C (S-video) signal input (IN) and output (OUT) terminals. The output terminal is bridge-connected.  
 IN : Y/C-separated (S-video) video signal input terminal  
 OUT : Bridge-connected Y/C-separated (S-video) signal output terminal
- 14 Audio A terminals [AUDIO A IN/OUT]**  
 Input (IN) and output (OUT) terminals for the audio signal corresponding to the VIDEO A terminals **11**.  
 The output terminal is bridge-connected.  
 IN : Audio signal input terminal  
 OUT : Bridge-connected audio signal output terminal  
**Notes:**  
 • For corresponding video signals, use the VIDEO A terminal **11**.  
 • Also refer to BASIC CONNECTION EXAMPLE on page 12.
- 15 Audio B terminals [AUDIO B IN/OUT]**  
 Input (IN) and output (OUT) terminals for the audio signals corresponding to the VIDEO B terminals **12** or VIDEO B (Y/C) **13**.  
 The output terminal is bridge-connected.  
 IN : Audio signal input terminal  
 OUT : Bridge-connected audio signal output terminal  
**Notes:**  
 • For corresponding video signals, use the VIDEO B terminals **12** or VIDEO B (Y/C) terminals **13**.  
 • Also refer to BASIC CONNECTION EXAMPLE on pages 12 and 13.

# CONTROLS AND FEATURES (cont'd)

## REAR VIEW

<Rear Panel>

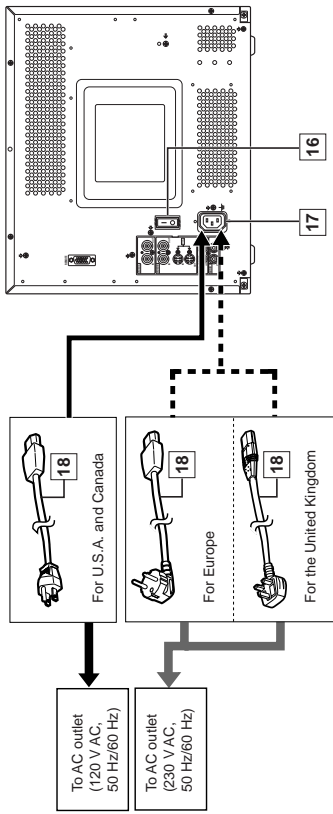

### 16 Main power switch

Press the switch to turn the main power ON or OFF. When the main power is ON, the power indicator on the front panel lights in orange and the monitor enters the standby mode.

I : ON    O : OFF

### 17 AC inlet [AC IN]

Power input connector. Connect the provided AC power cord (16) to an AC outlet (120 V AC or 230 V AC, 50 Hz/60 Hz).

### 18 Power cord

Connects the provided power cord (120 V AC or 230 V AC, 50 Hz/60 Hz) to the AC IN connector (17).

#### Caution:

In North America (USA and Canada), this monitor comes with one power cable. In Europe and the United Kingdom, two power cables are provided (one for use in continental European countries and the other for the UK). Be sure to use the power cable that is appropriate for the AC outlets used in your region. If none of the power cables provided is suitable, please contact your dealer or qualified service personnel to obtain the correct type of power cable.

# HOW TO HANDLE BASIC OPERATIONS

## BASIC OPERATION

1. Press the main power switch to turn on the power.
2. Press the POWER switch to turn on the power.



**ON** : Power turns ON. (Power indicator: lit)  
**Green**: The main power is ON, and the monitor's power is ON (in the normal operation mode).  
**OFF** : Power turns OFF. (Power indicator: unlit)  
**Orange** : The main power is ON, but the monitor's power is OFF (in the standby mode).  
**Unlit** : The main power is OFF.

3. Press the INPUT SELECT buttons to choose input.

Select video/audio signals input to terminals on the rear panel. The selected button lights in green.

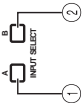

INPUT SELECT buttons	Terminals on the rear panel
① Input A (VIDEO)	Video signal input VIDEO A terminal
② Input B (VIDEO Y/C)	VIDEO B terminal VIDEO B (Y/C) terminal
③ Input C (VIDEO Y/C)	VIDEO B (Y/C) terminal AUDIO B terminal

Note: The Y/C (S-video) terminal has priority.

4. Press the VOLUME/SELECT buttons to adjust the speaker volume.

Press this button to display the speaker volume level on the screen.



**+** : The Built-in speaker volume is increased. (00 → 50)  
**-** : The Built-in speaker volume is decreased. (50 → 00)  
 \* Screen indication will disappear about 10 seconds after operating.  
 \* The on-screen display goes off when you press MENU button.

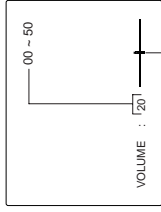

## PICTURE ADJUSTMENT

1. Press select buttons corresponding to the item you want to adjust.

### CHROMA CONTRAST

The item you select is displayed on the screen.  
 ① Chroma control : Press the CHROMA/PHASE button once.  
 ② Phase control : Press the CHROMA/PHASE button twice.  
 ③ Contrast control : Press the CONTRAST/BRIGHT button once.  
 ④ Brightness control : Press the CONTRAST/BRIGHT button twice.



\* Pressing the CHROMA/PHASE button and CONTRAST/BRIGHT button together will display the selected item on the screen. CHROMA and CONTRAST have priority. When no item is shown on screen, CHROMA and CONTRAST have priority.

2. Adjust with the VOLUME/SELECT buttons.



Items	VOLUME/SELECT button
CHROMA (Chroma)	- lighter + deeper
PHASE (Phase)	- reddish + greenish
CONTRAST (Contrast)	- lower + higher
BRIGHT (Brightness)	- darker + brighter

\* Screen indication will disappear about 10 seconds after operating.  
 \* The on-screen display goes off when you press MENU button.

### About the STATUS indication

• With the COLOR SYSTEM setting set to AUTO mode, when you turn on the power or select inputs, the color system indication appears for about 3 seconds on the screen while PAL or NTSC signals are being detected. It does not appear when receiving a BW signal or when no signal is input. Refer to page 8 for more information about COLOR SYSTEM setting and page 9 for more information about STATUS indication setting.

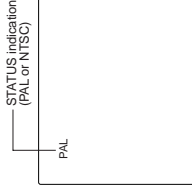

### Notes:

- Phase control is effective only in the NTSC color system mode.
- Chroma control is not effective when receiving BW or when no signal is input.
- When CHROMA is adjusted to "-40," the picture becomes less colorful.
- "NO EFFECT" is displayed (for about 3 seconds) when your selected function has no effect.

# HOW TO USE THE MENU FUNCTIONS

## DISPLAY AND SELECTION IN THE <MENU> SCREEN MODE (SETTING)

You can set the following menu items. Set them depending on your needs.

- SHARPNESS
- COLOR SYSTEM
- COLOR TEMP.
- ASPECT RATIO

### 1. Press the MENU button.

The <MENU> screen is displayed.  
\* The on-screen display goes off automatically after about five minutes with operation performed.

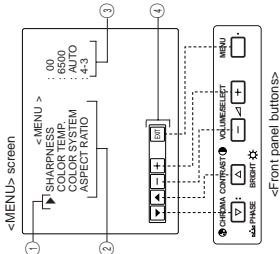

- 1 Selection mark (▶): Indicates the menu item you select.
- 2 Menu item: Menu items you can select.
- 3 Setting display: Indicates the current settings (value).
- 4 Function display: The functions of the front panel buttons (5 buttons on the left) correspond to the function displayed.

Front panel button	Function displayed	Contents
CHROMA/PHASE	▼	Forwards selection mark (▶)
CONTRAST/BRIGHT	▲	Reverses selection mark (▶)

### 3. Press the VOLUME/SELECT buttons to set.

Menu items	Purpose	Setting range
SHARPNESS	Picture sharpness	00 ↔ 01 •••••••••• 439 ↔ 440
COLOR TEMP.	Color temperature of white balance	6500 ↔ 9300
COLOR SYSTEM	Color system	AUTO ↔ NTSC ↔ AUTO ↔ PAL
ASPECT RATIO	Aspect ratio	4-3 ↔ 16-9

\* For normal use, leave the COLOR SYSTEM setting to AUTO.  
\*\* If reception is unsatisfactory in AUTO position, set it to the appropriate color system mode (NTSC or PAL).  
\*\*\* If reception is unsatisfactory in the <SET-UP MENU> screen, set to ON. PICTURE is displayed on the ASPECT RATIO setting and the aspect ratio cannot be changed from the <MENU> screen.

### 4. If you want to set the other menu items, repeat procedures 2 and 3.

### 5. Press the MENU button to quit.

Front panel button	Function displayed	Contents
MENU	EXIT	Quits (or Releases) the <MENU> screen

## ENGLISH

## DISPLAY AND SELECTIONS IN THE <SET-UP MENU> MODE (SETTING)

You can set the following setup menu items.

- H. POSITION
- V. POSITION
- CONTROL LOCK
- STATUS DISPLAY
- WHITE BALANCE
- ASPECT RATIO
- INPUT REMOTE

### Notes:

- Parameters for H. POSITION and V. POSITION can be set separately depending on the signal (Input A (VIDEO), Input B (VIDEO) or Input B (Y/C)) selected with the input select buttons on the front panel.
- Select the required video input with the input select buttons on the front panel in advance.
- WHITE BALANCE can be set independently at 6500 or 9300 for the color temperature value.
- Set COLOR TEMP. to 6500 or 9300 on the <MENU> screen beforehand.

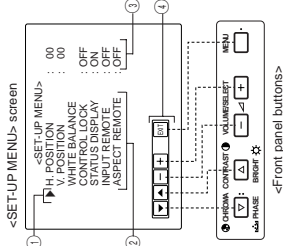

- 1 Selection mark (▶): Indicates the menu item you select.
- 2 Menu item: Menu items you can select.
- 3 Setting display: Indicates the current settings (value).
- 4 Function display: The functions of the front panel buttons (5 buttons on the left) correspond to the function displayed.

### 1. While pressing the MENU button, press the CHROMA/PHASE button.

The <SET-UP MENU> screen is displayed.

### 2. Press the CHROMA/PHASE or CONTRAST/BRIGHT button to select the desired menu item.

A selection mark (▶) is put next to the selected item.

Front panel button	Function displayed	Contents
CHROMA/PHASE	▼	Forwards selection mark (▶)
CONTRAST/BRIGHT	▲	Reverses selection mark (▶)

Function displayed	Contents
▼	Forwards the menu item.
▲	Reverses the menu item.
-	Lowers the adjustment value. (to the minimum)
+	Raises the adjustment value. (to the maximum)
▶	Forwards the setting value.
◀	Reverses the setting value.
EXIT	Exits the <SET-UP MENU> screen.
DRV	Selects DRIVE adjustment.
CUTO	Selects CUT OFF adjustment.
RB	Adjusts red and blue signal level.
RGB	Adjusts red, green and blue signal level.
DISP	Turns the ON-SCREEN display on or off. (This function is effective only in the DRIVE or CUT OFF adjustment mode.)

### 3. Press the VOLUME/SELECT buttons to set.

Front panel button	Function displayed	Contents
VOLUME/SELECT (+)	+	Increases (to max. value)
VOLUME/SELECT (-)	-	Decreases (to min. value)
CUTO	CUTO	Forwards the setting value
DRV	DRV	Selects DRIVE setting screen

### Notes:

- For WHITE BALANCE items, select the CUT OFF or DRIVE setting screen, then select the function display for adjustment.
- Press the EXIT (MENU) button to return to the <SET-UP MENU> screen.

# HOW TO USE THE MENU FUNCTIONS (cont'd)

Set-up menu items	Purpose	Settings
H. POSITION	Adjusts the horizontal position of the screen (*: Horizontal position shifts to the right; -: Horizontal position shifts to the left)	-5 → ..... → -01 → → 00 → +1 → ..... → +5
V. POSITION	Adjusts the vertical position of the screen (*: Vertical position moves up; -: Vertical position moves down)	-5 → ..... → -01 → → 00 → +1 → ..... → +5
WHITE BALANCE	Adjusts the white balance.	Selects the drive (DRV) or cut off (CUTO) adjustment. The selected setting screen is shown. Select the function display for adjustment. [ DRIVE ] R. DRIVE → -20 → -19 → ..... → -01 → -00 → +0 → +1 → +9 → +20 [ B. DRIVE ] → -20 → -19 → ..... → -01 → -00 → +0 → +1 → +9 → +20 [ CUTOFF ] R. CUT OFF → -20 → -19 → ..... → -01 → -00 → +0 → +1 → +9 → +20 [ G. CUT OFF ] → -20 → -19 → ..... → -01 → -00 → +0 → +1 → +9 → +20 [ B. CUT OFF ] → -20 → -19 → ..... → -01 → -00 → +0 → +1 → +9 → +20
CONTROL LOCK	Sets the operation buttons on the front panel to control lock mode.	OFF → ON
STATUS DISPLAY	Sets the status display of the color system.	OFF → ON
INPUT REMOTE	Sets external control of input selection (INPUT A/B).	OFF → ON
ASPECT REMOTE	Sets external control of the aspect ratio.	OFF → ON

\*1 Refer to HOW TO USE EXTERNAL CONTROL on page 14 for more details.

4. To set the other set-up menu items, repeat the procedures 2 and 3.

5. Press the MENU button to quit.

Front panel button	Function displayed	Contents
MENU 	EXIT	Quits (or Releases) the <MENU> screen

**Notes:**

- When the CONTROL LOCK function is set to ON, pressing operation buttons on the front panel will display the message "CONTROL LOCK ON!" on the screen for about 3 seconds.
- The CONTROL LOCK function is maintained even when the power is turned off.
- To turn off the CONTROL LOCK function, while holding the MENU button, press the CHROMA/PHASE LOCK function to OFF.
- Even when the CONTROL LOCK function is set to ON, the following operations are available:
  - Power Switch operation
  - Volume control with the VOLUME/SELECT buttons
  - Display or disappear of the <SET-UP MENU> screen.
- The STATUS DISPLAY function can be set to display (ON) or not display (OFF) the present color system when the power is turned on or the input signal is changed. Refer to page 7 for more information.
- When INPUT REMOTE is activated (ON), and any one of the INPUT A and B buttons is pressed, "REMOTE ON!" appears on screen for about 3 seconds.
- To enable external control (the INPUT or ASPECT RATIO function), set INPUT REMOTE or ASPECT REMOTE to ON.

# HOW TO INITIALIZE THE SCREEN DISPLAY AND SELECTIONS IN THE <SET-UP MENU> RESET MODE

## SETTING

You can set <MENU>- and <SET-UP MENU>- screen items, picture adjustment items and the volume level to their factory-set (initial) values.

1. Press the Power (⏻) switch to turn the power OFF (activate the standby mode).



<SET-UP MENU>- RESET screen

<SET-UP MENU>-RESET  
Are you sure?  
"Yes" then  
"No" then <MENU>

2. While pressing both MENU button and CHROMA/PHASE button, press the Power (⏻) switch to turn the power ON.

The <SET-UP MENU>-RESET screen is displayed.



**Note:**

- The <SET-UP MENU>-RESET screen will not be displayed if the MENU or CHROMA/PHASE buttons are pressed for a very short time. Keep pressing them until the display screen appears.

### 3. Setting

- Initialization is required.



- Press the VOLUME/SELECT (+) button. \* initialization is completed, and the <SET-UP MENU>-RESET screen disappears.

- Initialization is not required.



- Press the MENU button. \* Initialization is aborted, and the <SET-UP MENU>-RESET screen disappears.

Functions (Items)	Initialization (setting)
SHARPNESS	00
COLOR TEMP.	6500
COLOR SYSTEM	AUTO
ASPECT RATIO	4-3
H. POSITION	00
V. POSITION	00
WHITE BALANCE	
R. CUT OFF	00
G. CUT OFF	00
B. CUT OFF	00
R. DRIVE	00
B. DRIVE	00
CONTROL LOCK	OFF
STATUS DISPLAY	ON
INPUT REMOTE	OFF
ASPECT REMOTE	OFF
CHROMA PHASE BRIGHT	00
00	00
00	00
00	00
VOLUME	20



# BASIC CONNECTION EXAMPLE

**Notes:**

- Before connecting your system, make sure that all units are turned off.
- The illustration below shows some examples of different connections. Terminal connections may differ depending on the component connected. Be sure to refer to the instructions provided with the unit(s) you are connecting.
- Each pair of input (IN) and output (OUT) terminals are bridge-connected.
- If you're not connecting any equipment to a bridged output (OUT) terminal, be sure not to connect any other cables to the bridged output (OUT) terminal as this will cause the terminating resistance switch to open (auto terminate function).
- When making a bridge connection, connect the input (IN) and output (OUT) terminals on the monitor to separate video components.
- For example, if both terminals are connected to the same VCR, resonance may occur except during playback. This is caused by the same video signal "looping" between the VCRs, and is not a malfunction.
- Select the video input signal (INPUT A(VIDEO) or INPUT B (VIDEO/Y/C)) with the INPUT SELECT buttons on the front panel. When both VIDEO B terminals are connected (input) at the same time, the Y/C terminal has priority.

**VIDEO A Connection Example (Select Input A (VIDEO))**

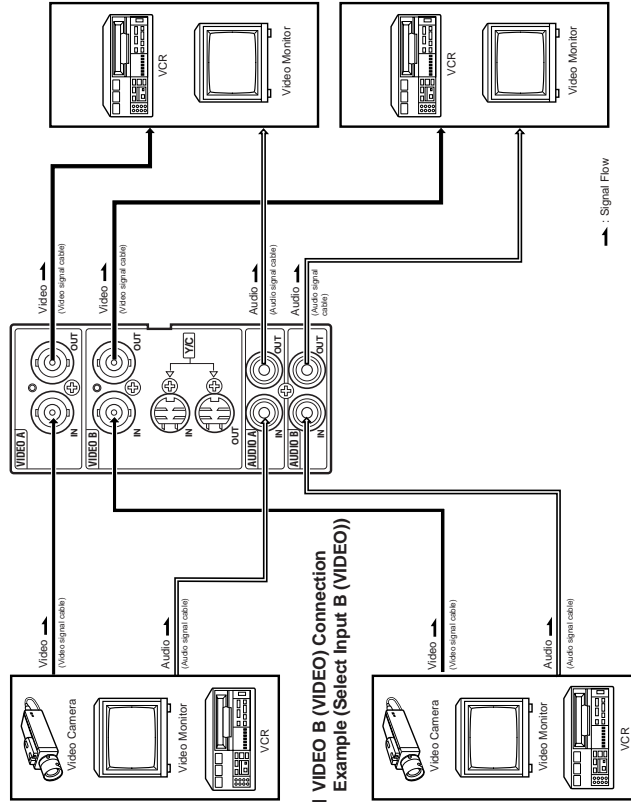

**VIDEO B (VIDEO) Connection Example (Select Input B (VIDEO))**

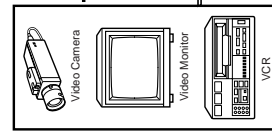

**VIDEO B (Y/C) Connection Example (Select Input B (Y/C))**

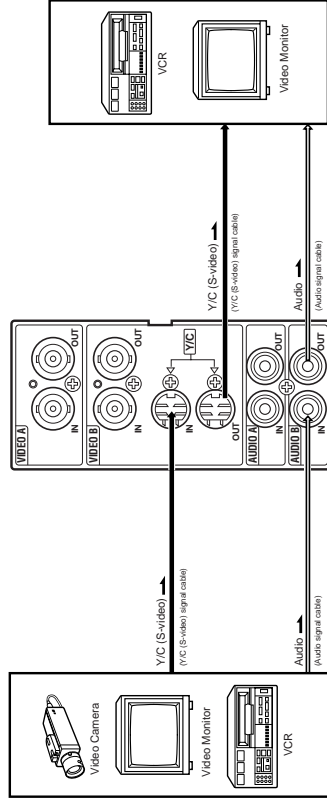

ENGLISH

→ : Signal Flow

# HOW TO USE EXTERNAL CONTROL

## ABOUT EXTERNAL CONTROL

This monitor is provided with an external control terminal.

The function is controlled with H and L (short-circuit/open with the 15th pin GND)

**Note:**

- The ASPECT RATIO or INPUT function can be controlled via the REMOTE terminal by setting ASPECT REMOTE or INPUT REMOTE to ON in the <SET-UP MENU>- screen. (Refer to pages 9 and 10.)

**Connections**

Connect (short-circuit) the 15th terminal (GND) to the 2nd or 10th terminals in the 3-line 15-pin D-sub connector. Do not connect other terminals.

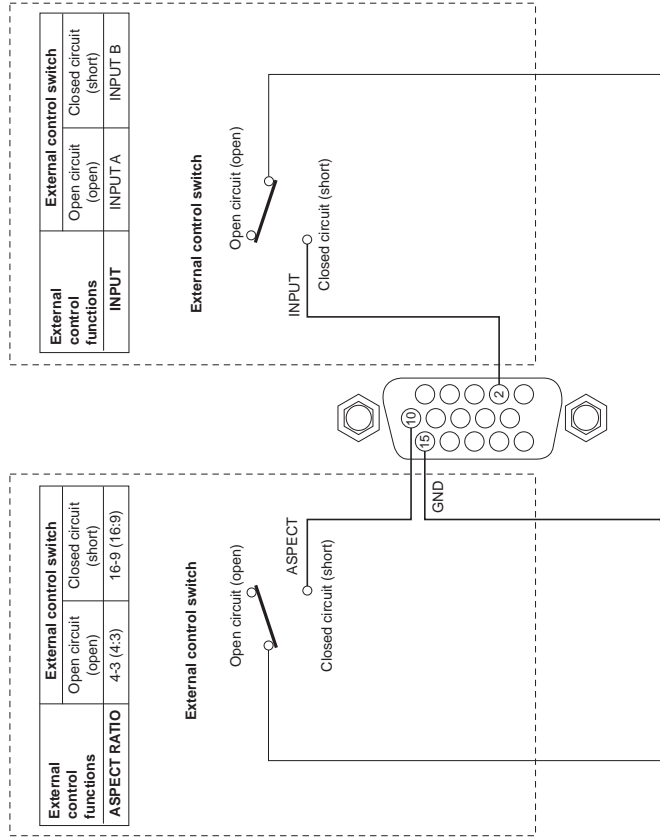

# TROUBLESHOOTING

Solutions to common problems related to your monitor are described here. If none of the solutions presented here solves the problem, unplug the monitor and consult a JVC-authorized dealer or service center for assistance.

Problems	Points to be checked	Measures (Remedy)
No power supply.	Is the power plug loosened or disconnected? Is the main power turned OFF?	Firmly insert the power plug. Turn the main power ON. (See page 6.)
No picture with the power on.	Is the video signal output from the connected component? Is the input signal selected properly? Is the video cable disconnected?	Set the connected component correctly. Select the required video signal input with the input select button. (See page 7.) Connect the video signal cable firmly. (See pages 12 and 13.)
No sound.	Is the audio signal output from the connected component? Is the volume output set to minimum?	Set the connected component correctly. Adjust the speaker volume with the VOLUME/SELECT button. (See page 7.)
Shaking picture.	Is the audio cable disconnected? Is the monitor close to a device generating a strong magnetic field?	Connect the audio signal cable firmly. (See pages 12 and 13.) Move the device away from the monitor until the picture stabilizes.
No colors, wrong color, or dark picture.	Is the color system selected properly? Has the picture control setting (CONTRAST, BRIGHT, CHROMA or PHASE) been changed?	Set COLOR SYSTEM in the <MENU>- screen to AUTO. (See page 8.) Set each picture control to the standard setting. (See page 7.)
Unnatural, irregularly colored, or distorted picture.	Is the monitor close to a speaker, magnet or any other device generating a strong magnetic field?	Move the device away from the monitor and turn the monitor's power off. Wait at least 30 minutes, then turn the power on again.
Dark stripes appear at the top and bottom of the screen, picture vertically squeezed.	Is the aspect ratio set to 16:9?	Set ASPECT RATIO in the <MENU>- screen to [4 : 3 (4 - 3)]. (See page 8.) When controlling externally, ASPECT RATIO should be set to [4 : 3 (4 - 3)]. (See page 14.)
Function buttons on the front panel do not function.	Has control of the buttons been locked? (Has the CONTROL LOCK function been set to ON?)	Set CONTROL LOCK in the <SET-UP MENU>- screen to OFF. (See pages 9 and 10.)
The INPUT SELECT buttons do not function.	Is input selection under external control? (Has the INPUT REMOTE function been activated (ON)?)	Set INPUT REMOTE in the <SET-UP MENU>- screen to OFF. (See pages 9 and 10.)

**The following are not malfunctions:**

- When a bright still image (such as a white cloth) is displayed for a long period, it may appear to be colored. This is due to the structure of the cathode ray tube and will be deleted when another image is displayed.
- You experience a mild electric shock when you touch the picture tube. This phenomenon is due to a normal buildup of static electricity on the CRT and is not harmful.
- The monitor emits a strange sound when the room temperature changes suddenly. This is only a problem if an abnormality appears on the screen as well.
- If two or more monitors are operated next to each other, their images may shake or be distorted. This phenomenon is due to mutual interference; it is not a malfunction. Move the monitors away from each other until the interference disappears or turn the power off on any monitor that is not being used.



# SPECIFICATIONS

■ <b>Type</b>	: Color video monitor	■ <b>Built-in speaker</b>	: 8 cm round x 1 impedance of 8 Ω
■ <b>Color system</b>	: PAL, NTSC (3.58)	■ <b>Environmental conditions</b>	: Operation temperature: 5°C – 40°C (41°F – 104°F) Operation humidity: 20 % – 80 % (non-condensing)
■ <b>Picture tube</b>	: 44 cm (17") measured diagonally, 90° deflection, in-line gun, trio-dot type (phosphor dot-trio pitch 0.27 mm)	■ <b>Power requirements</b>	: 120 V/230 V AC, 50 Hz/ 60 Hz
■ <b>Effective screen size</b>	: Width 327.5 mm (12-7/8") Height 246.2 mm (9-5/8") Diagonal 407.1 mm (16-1/32")	■ <b>Power consumption</b>	: 1.1 A (120 V AC)/0.7 A (230 V AC)
■ <b>Scanning frequency</b>	: (H) 15.734 kHz (NTSC) 15.625 kHz (PAL) (V) 59.94 Hz (NTSC) 50 Hz (PAL)	■ <b>Dimensions</b>	: Width 395 mm (15-5/8") Height 334 mm (13-1/4") Depth 418 mm (16-1/2")
■ <b>Horizontal resolution</b>	: 750 TV lines or more	■ <b>Weight</b>	: 19.6 kg (43.2 lbs)
■ <b>Input terminals</b>		■ <b>Accessory</b>	: AC power cord
	<b>VIDEO A</b> : Composite video: 1 line, BNC connector x 2, 1 V(p-p), 75 Ω, negative sync (bridge connection possible, auto termination)		
	<b>VIDEO B</b> : Composite video: 1 line, BNC connector x 2, 1 V(p-p), 75 Ω, negative sync (bridge connection possible, auto termination) Y/C-separated: 1 line, mini-DIN 4-pin connector x 2 Y: 1.0 V (p-p), 75 Ω C (BURST): 0.286 V (p-p), 75 Ω (NTSC) 0.3 V (p-p), 75 Ω (PAL) (bridge connection possible, auto termination)		
	<b>AUDIO A</b> : 1 line (monaural), RCA pin x 2 0.5 V(rms), high-impedance (bridge connection possible)		
	<b>AUDIO B</b> : 1 line (monaural), RCA pin x 2 0.5 V(rms), high-impedance (bridge connection possible)		
	<b>REMOTE</b> : Point-of-contact connection, 1 line D-sub connector (15-pin, 3-line)		
■ <b>Audio power output</b>	: 1 W (monaural)		

\* Illustrations used in this manual are for explanatory purposes only. The appearance of the actual product may differ slightly.

\* Dimensions and weight are approximate.

\* E. & O. E. Design and specifications subject to change without notice.

## ■ Dimensions

Unit : mm (inch)

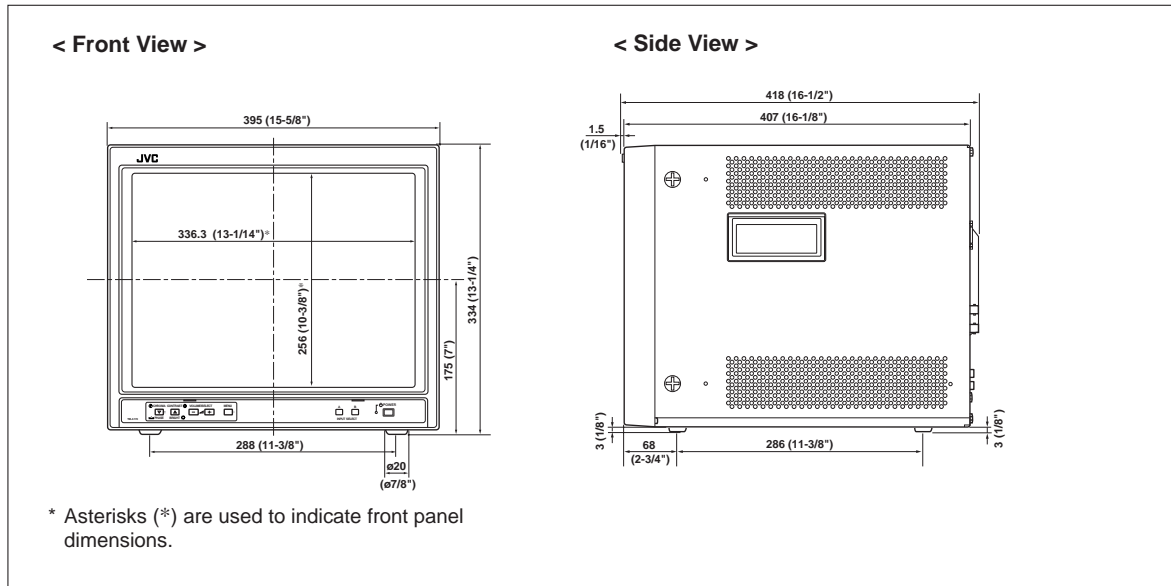

ENGLISH

## ■ Y/C (Mini DIN 4 pin) terminal specification

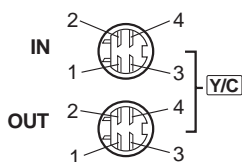

Pin No.	Signal
1	GND (Y)
2	GND (C)
3	Y
4	C

**-MEMO-**

---

**JVC**

VICTOR COMPANY OF JAPAN, LIMITED

© 2002 VICTOR COMPANY OF JAPAN, LIMITED



Printed in Thailand  
0702-Y-U-JMT